

ANOUR

G MODEL CORDLESS

Installation manual

Please, read our instructions before installing and using the product.

If you have any problems with the electrical installation, contact an electrician. Be sure to turn off the power before you start the installation. In some countries, all electrical installation must be carried out by professional electricians only. For further information, contact the relevant authorities.

Our products are for indoor use only. Check on a regular basis that the cord and other parts are not damaged. In this case, the product must not be used. Save these instructions for future use.

We use LED as a light source for our products. For replacement of LED contact Anour. The product should not be dismantled as it may get damaged. The product should not come into direct contact with water.

Our products are marked with the symbol of the crossed out wheelee bin. That means that the product should not be disposed of with other household waste. Our products must be recycled in accordance with local environmental regulations for the disposal of waste. In complying with this you will help to minimize any adverse effect on human and environmental health. If you have any questions please contact Anour. contact@anour.dk (2017)

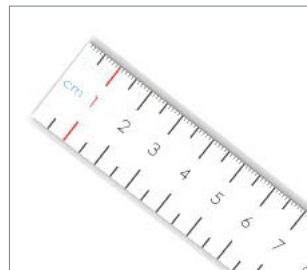
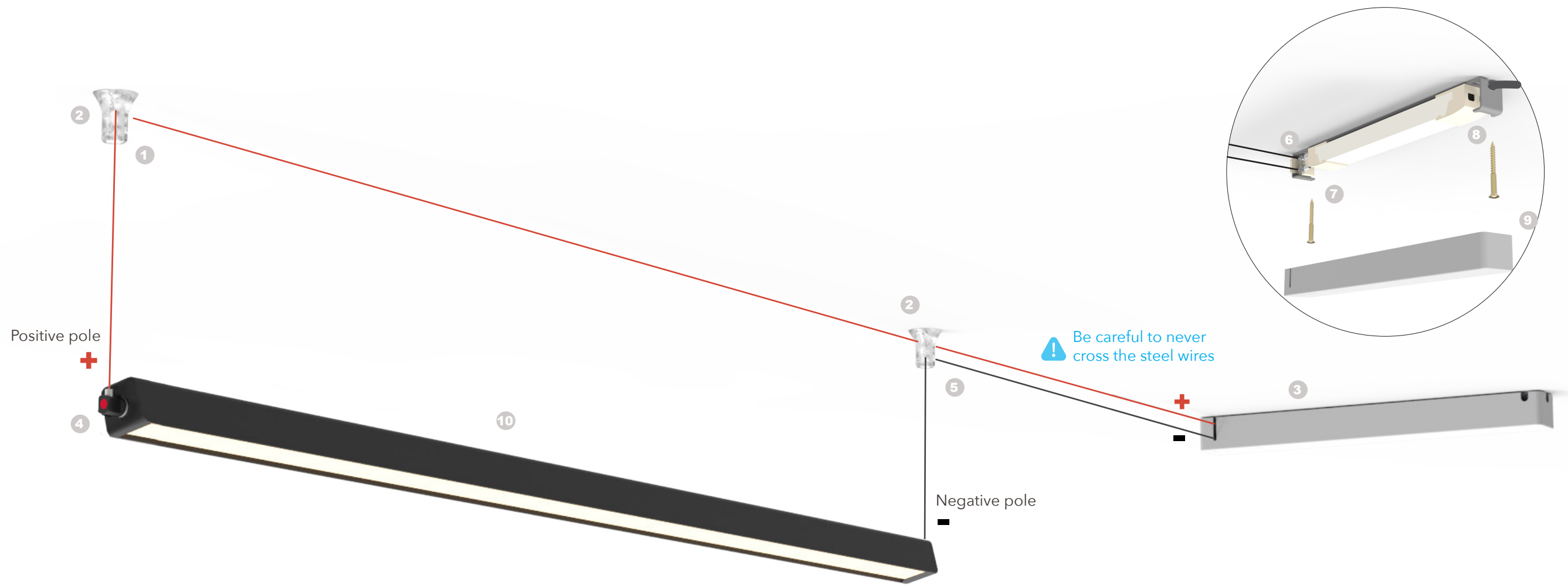

1. Measure distance between the suspension points. See below.



2. Drill holes and fasten the plastic ceiling components.

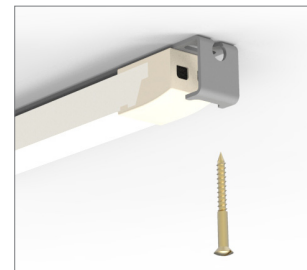

3. Position the driver box (see diagram below), drill holes and fasten it.

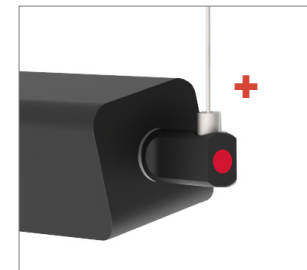

4. Attach the wires to the nipples and tightly fasten the wires to the lamp.

⚠ The positive pole of the lamp is indicated on the lamp with a red point sticker.



5. Insert the steel wires in the 2 plastic ceiling components. Assure that the wires are aligned.

⚠ Be careful to never cross the steel wires.

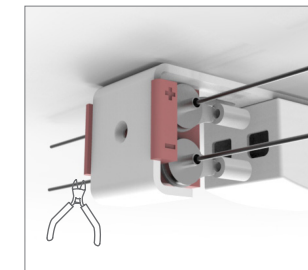

6. Insert the + wire in the + terminal and the - wire in the - terminal.

You can change the position of the poles by repositioning the wire grippers. ➡

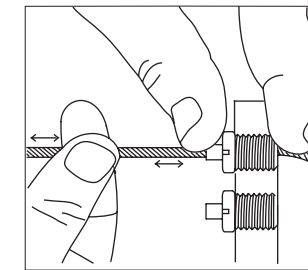

7. Adjust the height of the lamp by pressing the wire gripper and then, cut the excess wire, as shown.

We recommend suspending the light with a distance of +/- 60cm above a dining table. For kitchen table tops, we recommend +/- 70cm.

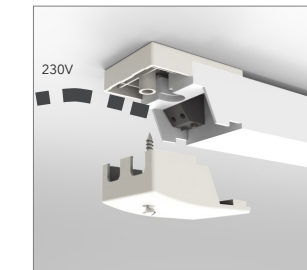

8. Connect the primary power cable to the terminals on the primary side of the power supply and then, fasten the screw of the safety cap.

⚠ Should be performed according to safety regulations.

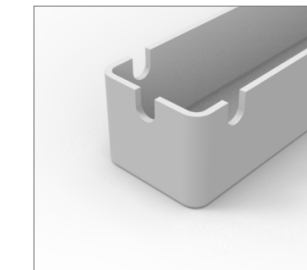

9. Cut out one input for the primary power cable (3 options shown) in the plastic lid and then attach the white lid to the power supply (magnetic closure).

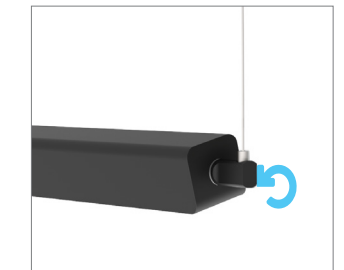

10. Adjust the angle of the lamp by rotating the body.

(Rotation 360°)

DIMENSIONS:

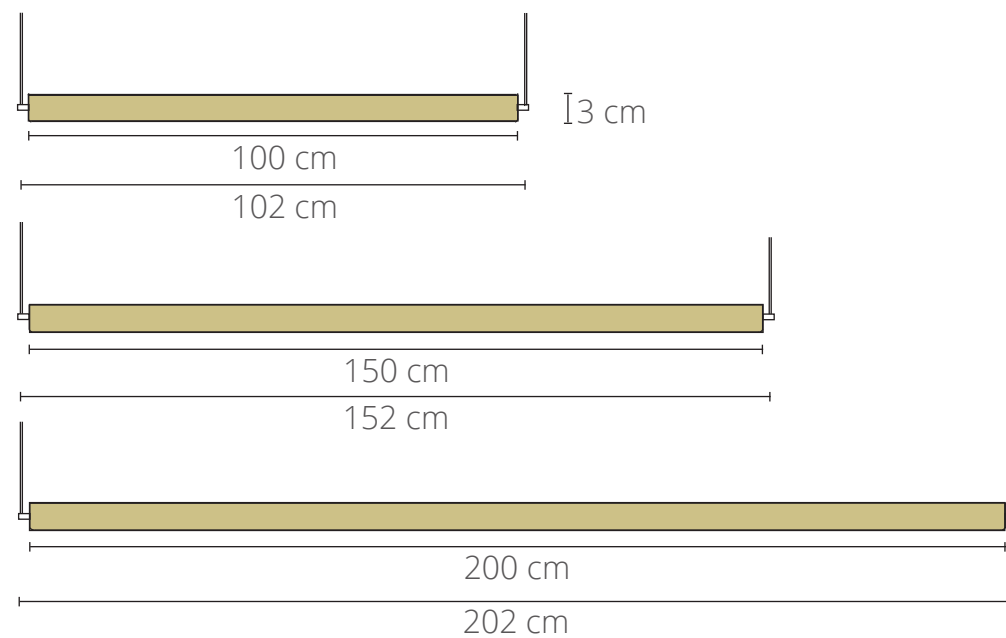

DRIVER BOX POSITION OPTIONS : DIAGRAM (TOP VIEW)

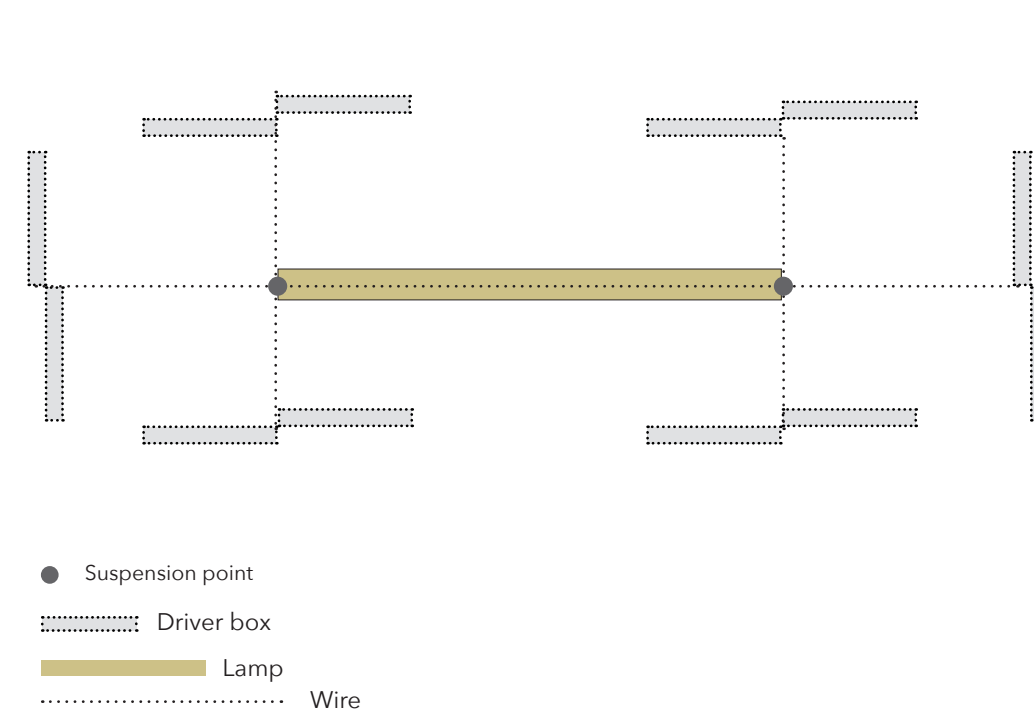

PARTS: (INCLUDED IN THE PACKAGE)

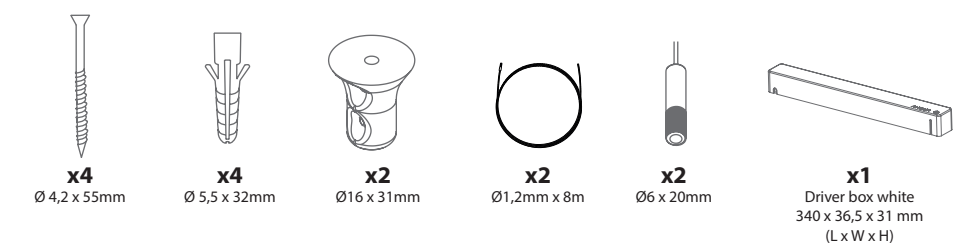

REQUIRED TOOLS: (NOT INCLUDED)

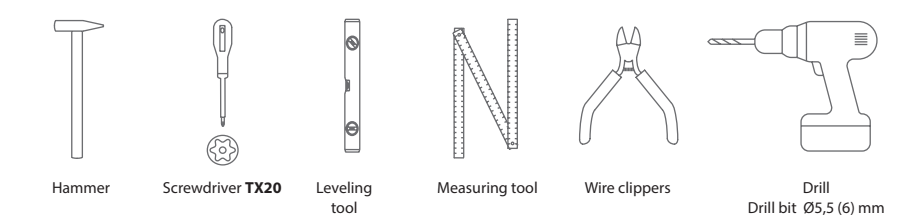

WIRING INSTALATION MANUAL

Check your order first, as you cannot combine multiple solutions.

If you have any problems with the electrical installation, contact an electrician. Be sure to turn off the power before you start the installation. In some countries, all electrical installation must be carried out by professional electricians only. For further information, contact the relevant authorities.

Trailing edge dimming is not available.

We do not supply power cable from outlet to power supply.

1. DIAGRAM STANDARD WITH TOUCH DIMMER BUTTON ON THE LAMP

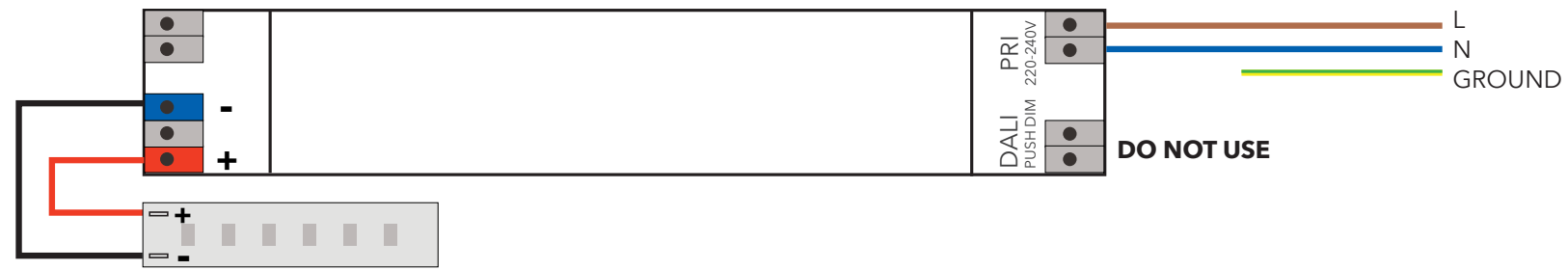

2. DIAGRAM DALI

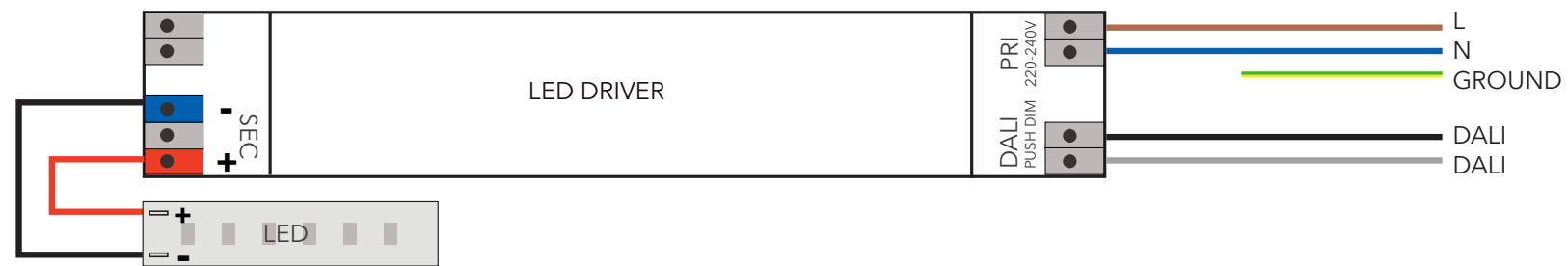

3. DIAGRAM PUSH DIM

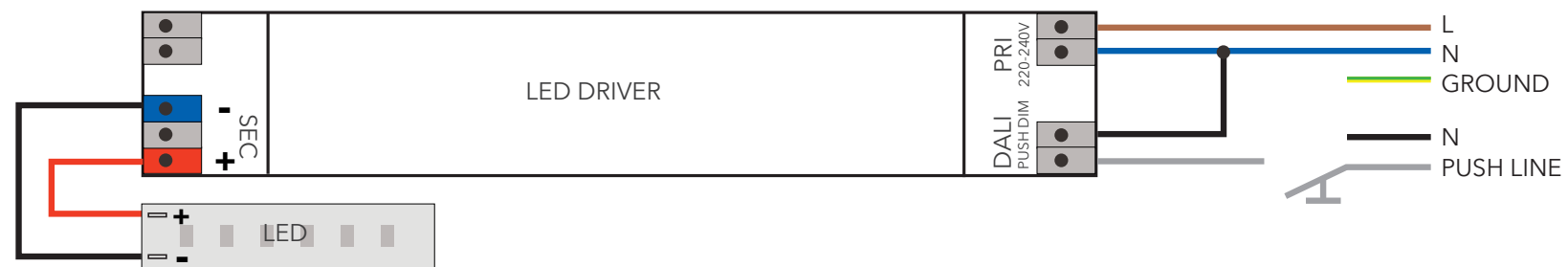

4. DIAGRAM 1-10V

